

# Technics SU-V8

Stereo Integrated  
DC Amplifier

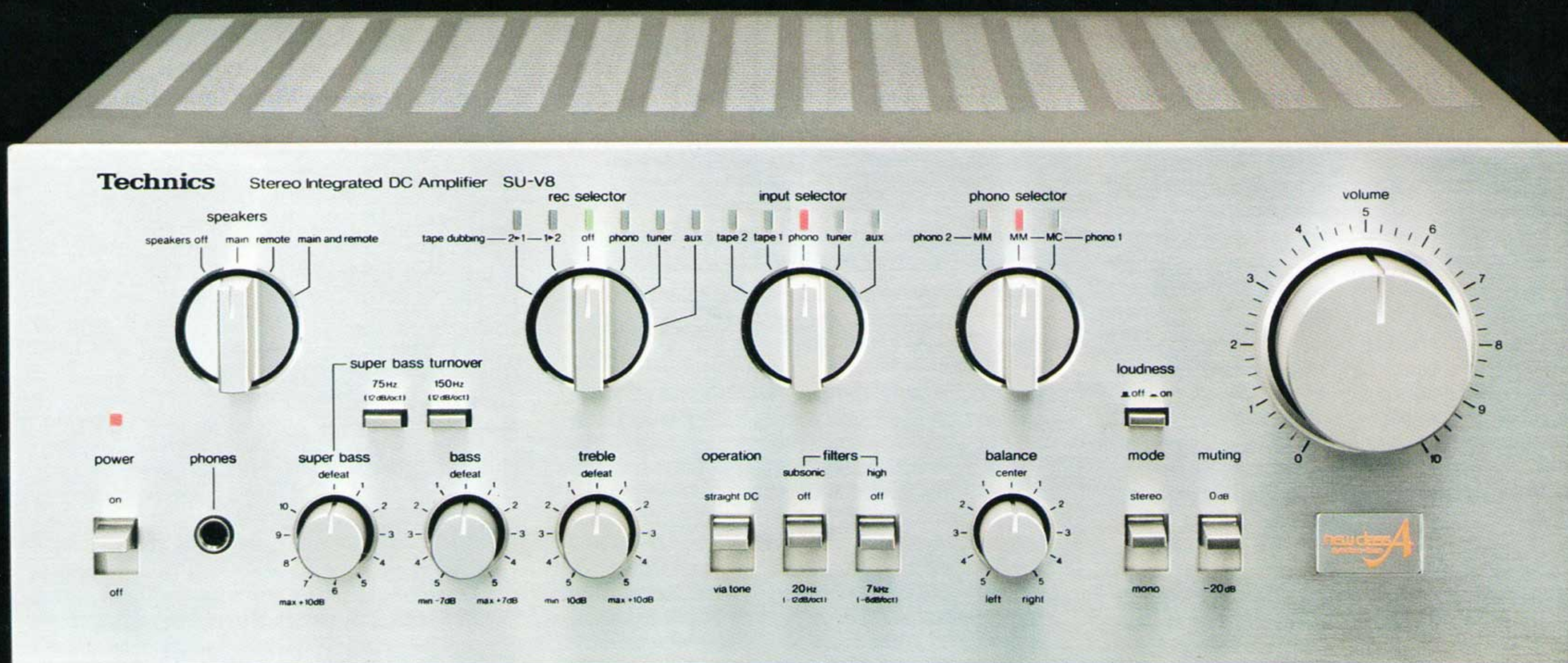

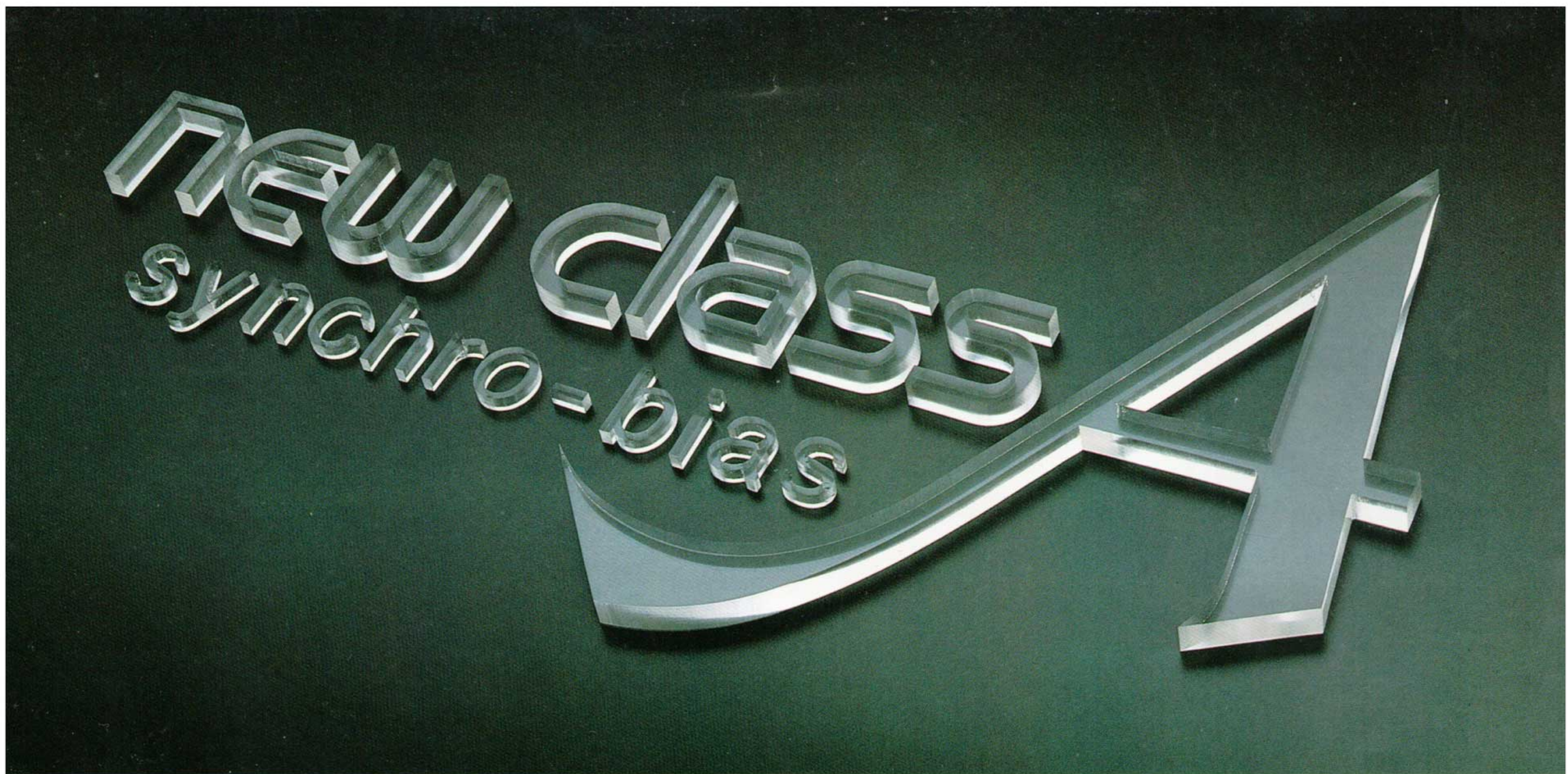

New Class A—a Technics development combines clean, class A amplifier design output with the high output power capabilities of class B design. You don't have to trade efficiency and price for sound quality, or distortion for high output.

In the new SU-V8 this translates into 105 watts per channel minimum continuous "RMS" into 8 ohms, from 20~20,000 Hz with no more than 0.005% total harmonic distortion. But more important than these impressive figures is the fact that the reproduced sound from this integrated amplifier exhibits the operational smoothness of conventional class A amplification. And yet the SU-V8 is available at a fraction of the cost of class A amplifiers.

From the performance viewpoint, the Super Bass control is something to get excited about. This control functions something like an electronic sub-woofer. You can use the Super Bass to improve the very low bass response of speaker systems, and also compensate for deficiencies in room acoustics. It will boost frequencies beginning at either 75 Hz or 150 Hz depending on your switch setting. Appreciative audiophiles will hear the realism that the enhancement or increased control of these frequencies adds to the music.

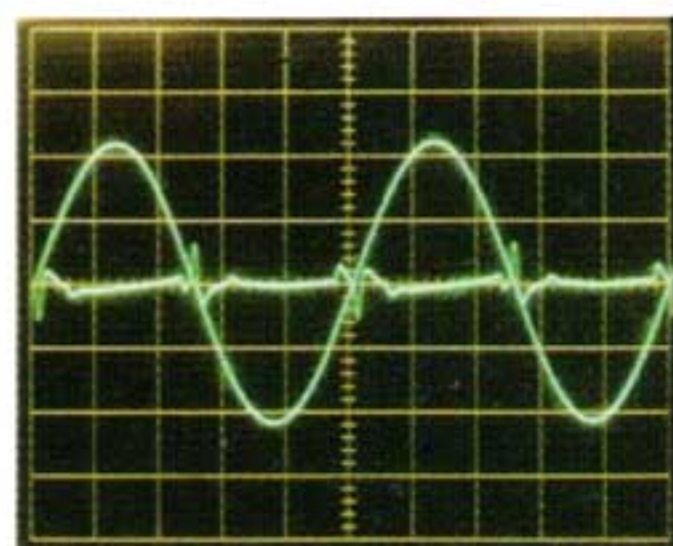

Class B amplifier output waveform and distortion waveform (at 20 kHz)

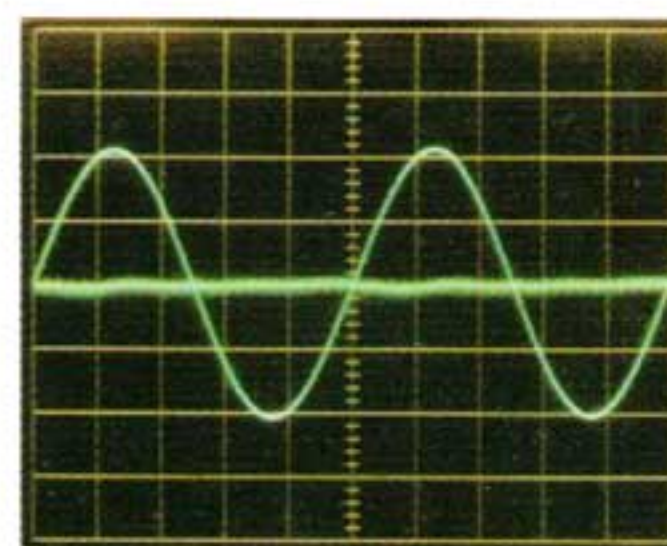

New class A amplifier output waveform and distortion waveform (at 20 kHz)

### New Class A and Straight DC Provide both Quality and Quantity

Quality of reproduced sound, and quantity of output power: these were our two objectives in developing the circuitry designs incorporated in the SU-V8.

Specifically, an audio amp must provide clean, clear, undistorted sound at all output levels and across the entire audio spectrum from 20 Hz to 20 kHz. To test the success of our circuit designs we have employed "3-Dimensional Analysis" (3DA). With the aid of a computer, this analysis system allows us to test performance at 4,000 different points and express the results in 3-dimensional graphic form. Our 3DA research indicates that in order to best satisfy

performance requirements within the audio spectrum, amplifiers should exhibit good performance characteristics from 0 Hz (DC) at the bottom of the low frequency range, all the way up to nearly 100 kHz in the ultra-high range. To achieve performance within these parameters we have utilized a number of special circuit configurations, the two most important of which are New Class A and Straight DC.

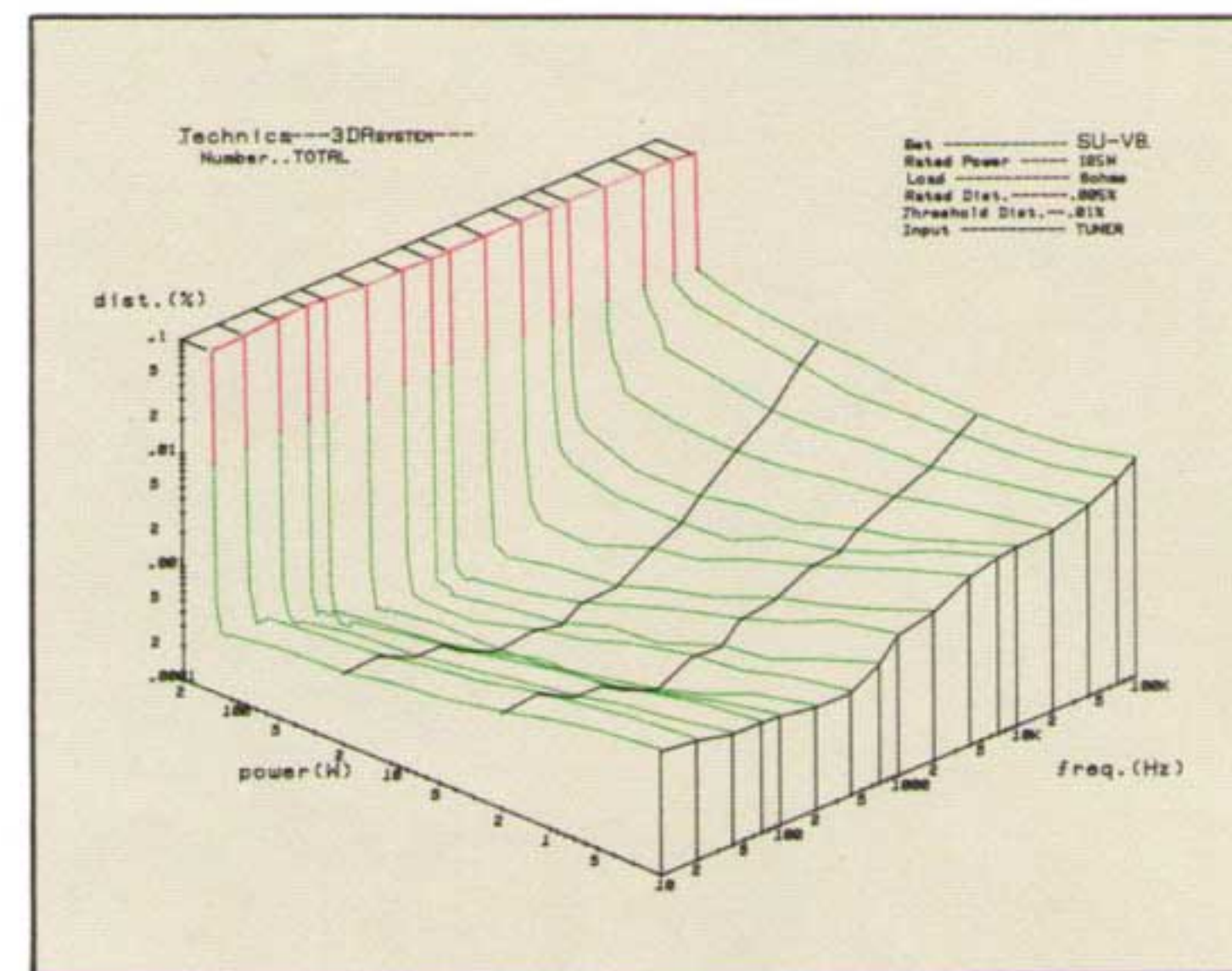

### New Class A with Synchro Bias for Excellent High-Frequency Response

"Switching distortion" is the major problem standing in the way of clean high-frequency response in class B and class AB amplifier designs. In class B designs, two output transistors are used for each channel. The "upper" transistor handles the positive half of the waveform and the "lower" handles the negative half. The problem is that as the signal crosses the zero point, one transistor turns off and the other turns on. In the process, switching distortion is generated. This takes the form of brief pulses with very sharp peaks, the effect of which is difficult to express in terms of total harmonic distortion. Nor is it a simple matter to use NFB (negative feedback) to remove switching distortion. In some cases, this switching distortion also results in intermodulation distortion that muddies the reproduced sound to a greater degree than might be

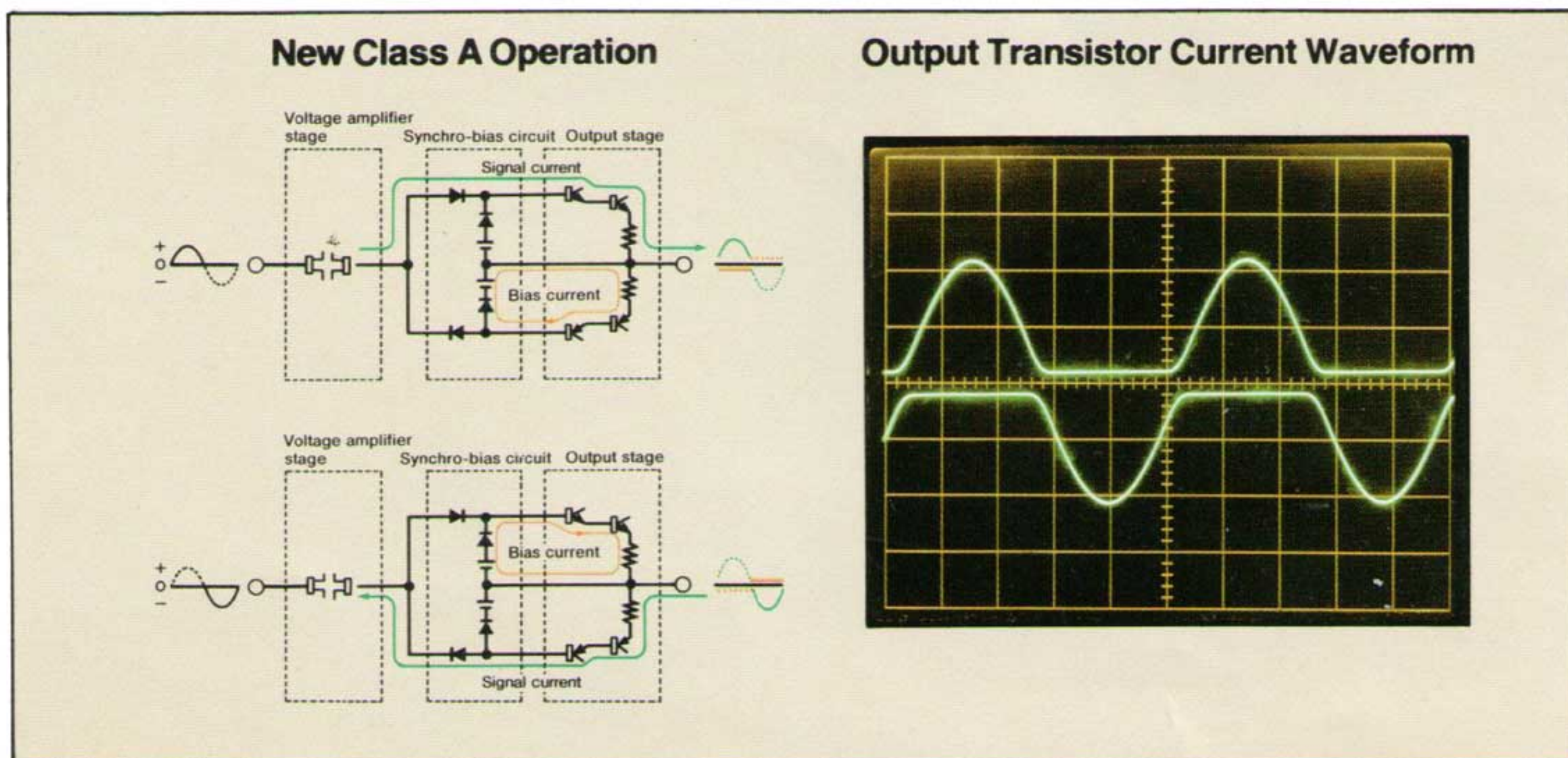

expected from a simple examination of an oscilloscope trace. In class A designs, the same transistor handles the entire waveform and a large idling current is required to operate the transistor even when there is no audio input signal! While this prevents any form of switching distortion, it also results in very low efficiency and means that large heat sinks must be provided to dissipate the large amounts of excess heat that is created. Price is correspondingly high.

In our New Class A circuitry, the output transistor bias current is synchronized with the positive and negative swings of the input signal so that output transistors are always in an active state. With this remarkable circuitry, no switching distortion is generated because the transistors are never allowed to switch off.

We call this synchronized operation "synchro bias". Not only does it prevent switching distortion in the output waveform, it also avoids presenting a nonlinear load to the voltage amplification stage, and it reduces predriver load fluctuation near the zero crossover point.

The result is the virtual elimination of crossover distortion. The New Class A effectively contends with switching and crossover distortion.

Distortion in the output waveform is virtually the same as the residual distortion waveform created by the test instruments used to measure it.

### Straight DC Configuration for Direct Coupling Between DC Power Amp Section and High-Level Input Signals

This design takes full advantage of the excellent low-range frequency response, phase linearity and low distortion inherent in our refined DC power amp design. By increasing the gain of the power amp section, we have made it possible to directly couple high-level inputs such as tuner, tape, and AUX sources to the power amp input. The resulting improvement in low-range fidelity is a good example of what can be achieved with an innovative yet simple approach to integrated amp design. In fact you could view this configuration as simply a phono equalizer plus DC power amp. While this characterizes the "simple is best" philosophy, a number of innovations were necessary to obtain certain performance goals. First of all, a high gain amp is required to raise typical "high level" inputs of 150 mV~200 mV to rated output level of 100 W. Furthermore, any tendency toward temperature-dependent DC drift must be avoided since the amp's high gain extends all the way down to DC in the low range.

To obtain high gain, the amp employs a linear cascode, 3-stage Darlington configuration which significantly improves open loop performance. As a result, only 45 dB NFB is required to achieve the 0.005% THD rating at 105 W output.

To combat DC drift, 1-chip dual FETs are used in the first stage differential amplifier. Since this prevents mutual temperature differences, DC drift is reduced to a mere  $\pm 10$  mV from  $-10^{\circ}\text{C}$  to  $+50^{\circ}\text{C}$ .

### Concentrated Power Block (CPB) Prevents Distortion from Electromagnetic Induction

We wanted to be certain that the strikingly clean high-range response of our New Class A synchro bias circuitry would not be subjected to distortion caused by electromagnetic induction. To this end, we utilize a concentrated power block (CPB) to prevent electromagnetic induction between those portions of the circuitry

handling large current and those portions handling smaller signals. In other words the power supply and output stage are in one integrated unit to allow the shortest possible connections. And with the addition of low-impedance laminated bus lines, the power supply loop was significantly streamlined. Another advantage of CPB is that it helps in quality control by virtually eliminating significant differences in performance between individual units. Consequently you can expect no more than the rated 0.005% THD for any individual SU-V8 amp.

### ICL Phono EQ Circuit Employing Ultra-Low Noise FETs Permits Direct MC Cartridge Connection

The first stage of the phono equalizer is a differential amplifier employing ultra-low-noise dual FETs. As a result, no input capacitors are needed (ICL) and a mere increase in equalizer gain is all that is needed for MC cartridge compatibility, without any additional pre-preamp or step-up transformer. Whether the cartridge is MC or MM, the only capacitor remaining in the entire amp circuit is the EQ output capacitor when the amp is in the straight DC mode.



### Independent Right and Left Power Supplies Using 2 Transformers

An amp power supply must have enough extra power to adequately handle impedance changes of speakers. In other words a good way to judge the power and quality of one amp would be to evaluate its characteristics not only with a rated output into the standard 8 ohms, but also into 4 ohms. The output of the SU-V8 into 4 ohms is a high 150 W + 150 W (1 kHz, 0.008% THD), and this is clear evidence that the amp truly is a versatile performer.

The two completely different power supplies of the SU-V8 also employs right and left power transformers as well as rectifier and ripple circuits to assure stable DC power. The independent right and left channel transformers are floated in a special resin within shielded cases. Because they float in this resin, transformer hum (mechanical vibration) is lessened and the result is a "silent" high-power amp.

### Super Bass Brings The Deepest Bass Sounds to Life

Thanks to improved recording and cutting techniques, many modern records are cut with the same level for the super low sounds below 50 Hz as for those at 1 kHz. Reproduction of these super low sounds are closely connected with concert hall atmosphere and musicality. The frequencies enhanced by the Super Bass controls add much to the realism

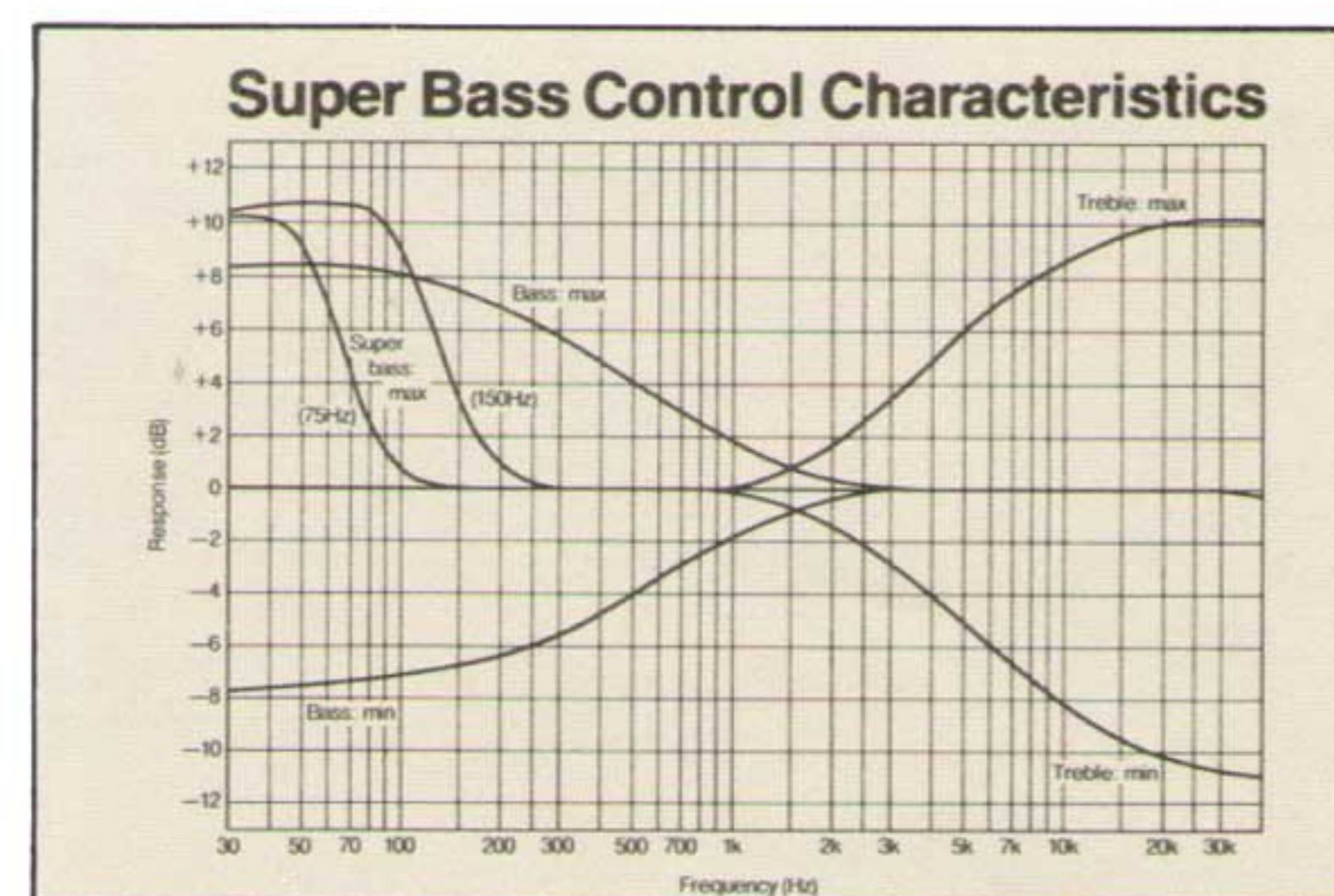

of the music. If you ever tried to get this deep bass reproduction from a bookshelf speaker by using conventional butterfly-type tone controls, you know the low end frequency characteristics of the speaker could be over-adjusted as shown in the graph and the speakers sound much too boomy.

The Super Bass in the Technics SU-V8 was conceived to compensate for deficiencies in conventional low-range (bass) tone controls. Using a shelving-tone having a 12dB/oct. gain and a maximum boost of 10 dB, frequency characteristics of the speaker can be expanded by as much as 1 octave in the deep bass range. A choice of two turnover frequencies, 75 Hz and 150 Hz are provided to match speaker characteristics. The Super Bass can be used to regulate, by increasing, frequency characteristics in the very low range of the speakers, and also for decreasing and removing boominess in the mid-bass when used in conjunction with the regular bass control.

### Independent Recording Selector with 2-way Dubbing

With this versatile arrangement you can record from one source while listening to another because the input selector and recording selector are separate. This amplifier has the tape inputs available on both the input selector and recording selector so you can, for example, dub from one tape deck to another while listening to a separate program source.

### Other Features

- Remote action switches eliminate much internal wiring.
- Protection relay circuit with automatic reset.
- High filter to cut out high-frequency noise such as record scratches and tape hiss. Subsonic filter reduces low-frequency noise.
- Front-panel speaker selector lets you select either two pairs of speaker systems (A or B) or both at once (A+B).
- Tone controls defeated in center "click" position.

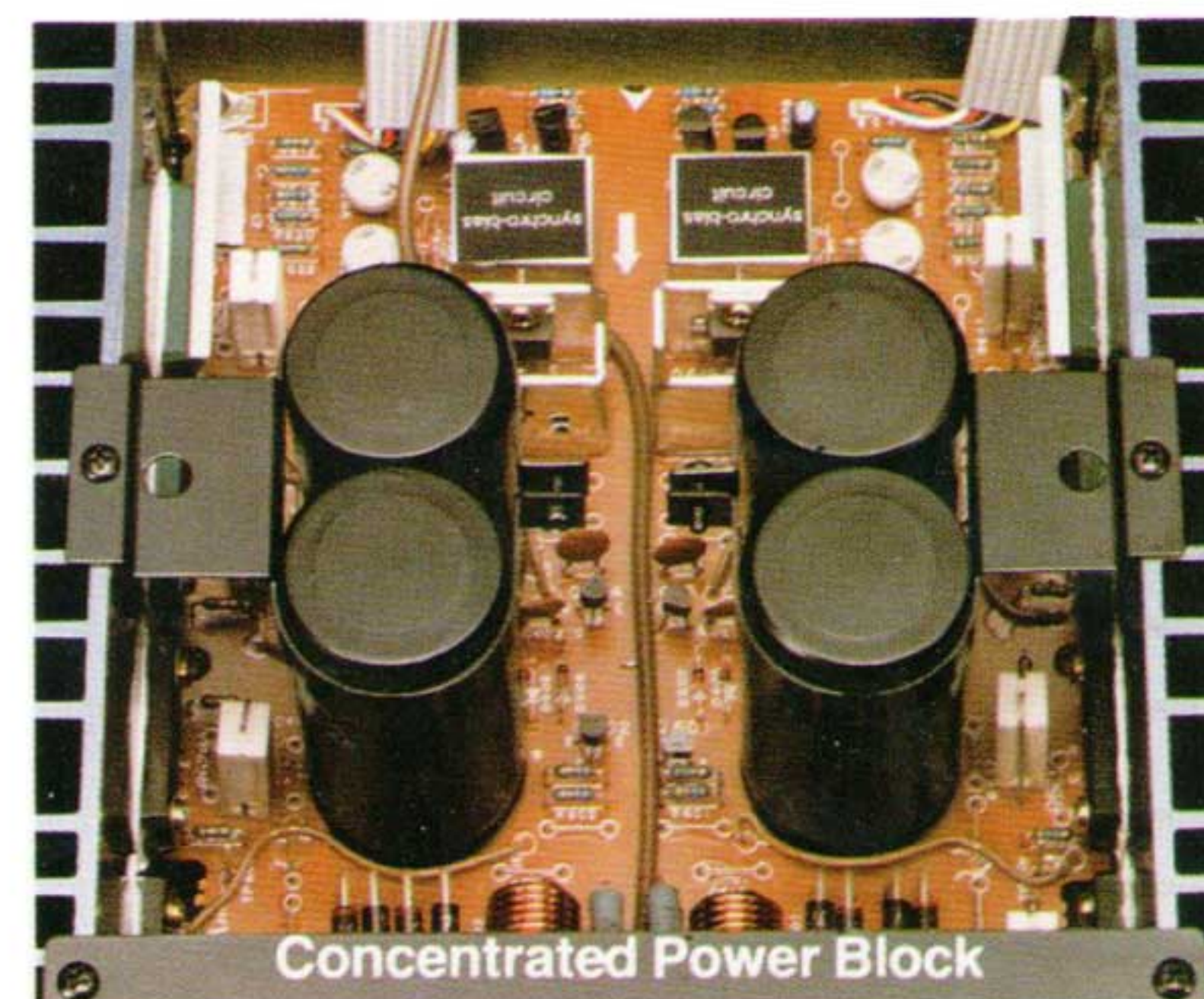

## Rear Panel Facilities

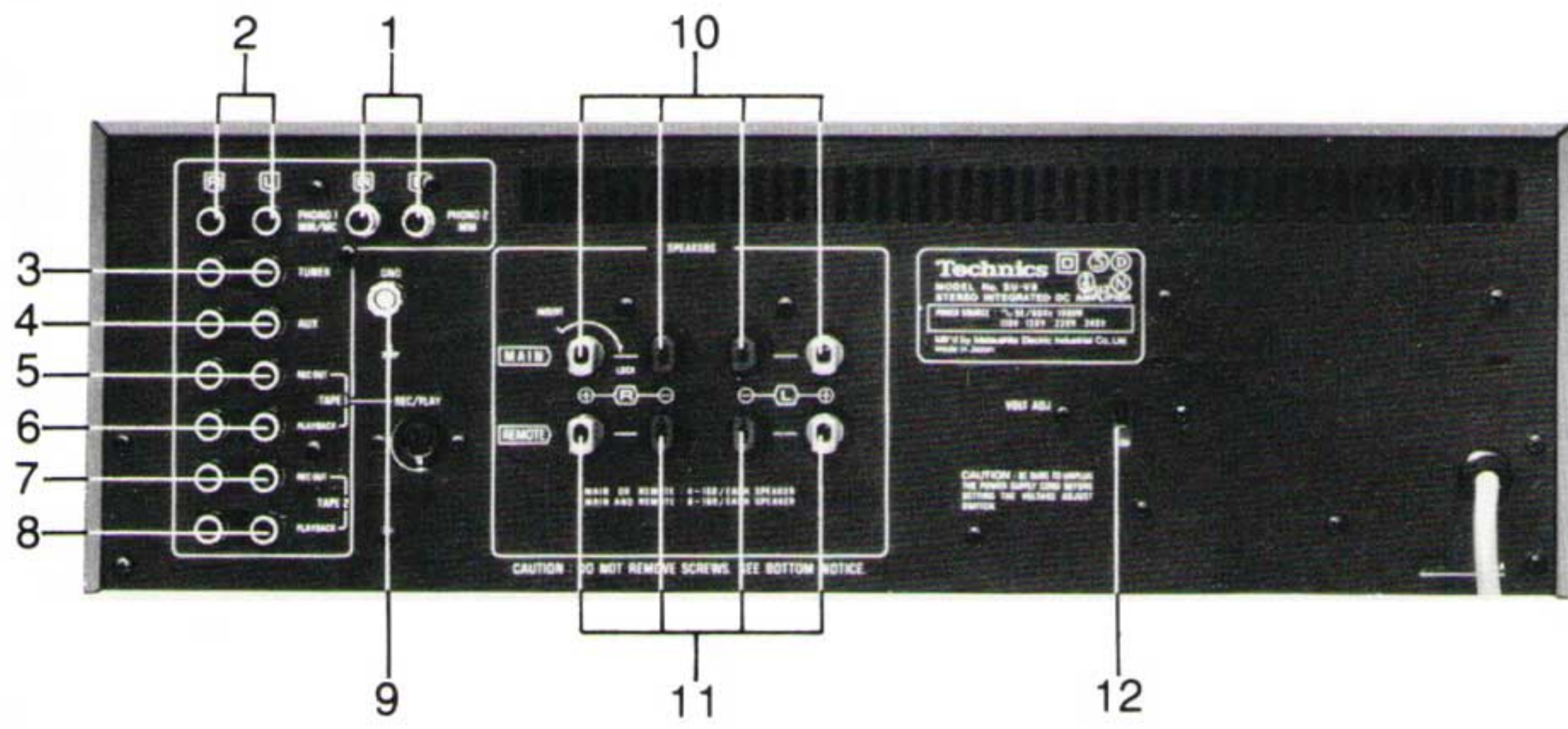

- |                                  |                                |
|----------------------------------|--------------------------------|
| 1. PHONO 2 inputs (MM)           | 8. TAPE DECK 2 Playback inputs |
| 2. PHONO 1 inputs (MM/MC)        | 9. Ground terminal             |
| 3. TUNER inputs                  | 10. Speaker terminals (main)   |
| 4. AUX inputs                    | 11. Speaker terminals (remote) |
| 5. TAPE DECK 1 Recording outputs | 12. Voltage adjuster           |
| 6. TAPE DECK 1 Playback inputs   |                                |
| 7. TAPE DECK 2 Recording outputs |                                |



The ST-S7 Quartz Synthesizer FM/AM Stereo Tuner is just the right companion for your SU-V8. With the same clean, attractive styling and outstanding performance standards, it perfectly complements the SU-V8 Integrated DC Amplifier.

## Technical Specifications (DIN 45 500)

### AMPLIFIER SECTION

|  |                            |
|--|----------------------------|
| 20 Hz~20 kHz continuous power output<br>both channels driven | 140W×2 (4Ω)<br>105W×2 (8Ω) |
| 40 Hz~16 kHz continuous power output<br>both channels driven | 140W×2 (4Ω)<br>105W×2 (8Ω) |
| 1 kHz continuous power output<br>both channels driven        | 150W×2 (4Ω)<br>115W×2 (8Ω) |
| Total harmonic distortion<br>rated power                     |                            |
| at 20 Hz~20 kHz  | 0.008% (4Ω)<br>0.005% (8Ω) |
| at 40 Hz~16 kHz  | 0.008% (4Ω)<br>0.005% (8Ω) |
| at 1 kHz   | 0.008% (4Ω)<br>0.005% (8Ω) |
| half power   |                            |
| at 20 Hz~20 kHz  | 0.004% (8Ω)                |
| at 1 kHz   | 0.002% (8Ω)                |
| -26 dB power at 1 kHz  | 0.05% (4Ω)                 |
| 50 mW power at 1 kHz   | 0.1% (4Ω)                  |
| Intermodulation distortion<br>rated power                    |                            |
| at 250 Hz:8 kHz=4:1, 4Ω                                      | 0.01%                      |
| at 60 Hz:7 kHz=4:1, SMPTE, 8Ω                                | 0.007%                     |
| Power bandwidth both channels driven, -3 dB                  |                            |
| THD. 0.03%, 5 Hz~70 kHz (4Ω)                                 |                            |
| THD. 0.02%, 5 Hz~70 kHz (8Ω)                                 |                            |
| Residual hum & noise (Straight DC)                           | 0.4 mV                     |
| Damping factor   | 30 (4Ω), 60 (8Ω)           |
| Headphones output level & impedance                          | 700 mV/330Ω                |

|  |  |
|--|--|
| Load impedance                               |  |
| MAIN or REMOTE                               | 4Ω~16Ω   |
| MAIN and REMOTE                              | 8Ω~16Ω   |
| Muting                                       | -20 dB   |
| Input sensitivity & impedance                |  |
| PHONO MM                                     | 2.8 mV/47 kΩ                                     |
| MC   | 180 μV/47Ω                                       |
| TUNER, AUX                                   | 180 mV/36 kΩ                                     |
| TAPE 1, REC/PLAY                             | 200 mV/39 kΩ                                     |
| TAPE 2                                       | 180 mV/36 kΩ                                     |
| Phono maximum input voltage<br>at 1 kHz, RMS |  |
| MM   | 150 mV   |
| MC   | 10 mV  |
| S/N  |  |
| rated power 4Ω                               |  |
| PHONO MM                                     | 78 dB (88 dB, IHF '66)                           |
| MC   | 72 dB<br>(72 dB, IHF '66, 250 μV input)          |
| TUNER, AUX                                   | 94 dB (106 dB, IHF '66)                          |
| -26 dB power 4Ω                              |  |
| PHONO MM                                     | 72 dB  |
| MC   | 69 dB  |
| TUNER, AUX                                   | 70 dB  |
| 50 mW power 4Ω                               |  |
| PHONO MM                                     | 67 dB  |
| MC   | 66 dB  |
| TUNER, AUX                                   | 67 dB  |
| Frequency response                           |  |
| PHONO  | RIAA standard curve ±0.3 dB<br>(30 Hz~15 kHz)    |
| TUNER, AUX, TAPE (Straight DC)               | DC~150 kHz (-3 dB)<br>+0, -0.2 dB (20 Hz~20 kHz) |

|                                     |  |
|-------------------------------------|--|
| Tone controls                       |  |
| SUPER BASS                          | 30 Hz, +10 dB~0 dB                                     |
| BASS                                | 100 Hz, +7 dB~-7 dB                                    |
| TREBLE                              | 20 kHz, +10 dB~-10 dB                                  |
| Turnover frequencies                |  |
| SUPER BASS                          | 75 Hz, 150 Hz (-12 dB/oct)                             |
| BASS                                | 500 Hz   |
| TREBLE                              | 2 kHz  |
| High-cut filter                     | 7 kHz, -6 dB/oct                                       |
| Subsonic filter                     | 20 Hz, -12 dB/oct                                      |
| Loudness control (volume at -30 dB) | 50 Hz, +7 dB   |
| Output voltage & impedance          |  |
| REC OUT                             | 180 mV   |
| REC/PLAY                            | 30 mV/82 kΩ  |
| Channel balance                     |  |
| AUX, 250 Hz~6,300 Hz                | ±1.0 dB  |
| Channel separation                  |  |
| AUX, 1 kHz                          | 55 dB  |
| <b>GENERAL</b>                      |  |
| Power consumption                   | 1000 W   |
| Power supply                        | AC 110/120/220/240 V, 50/60 Hz                         |
| Dimensions                          | 430×153×395 mm<br>(W×H×D) (16-15/16"×6-1/32"×15-9/16") |
| Weight                              | 15.5 kg (34.2 lb)                                      |

Note: Total harmonic distortion is measured by the digital spectrum analyzer (HP3045 system).

# Technics

## Matsushita Electric